

ASTRO P25
APX™ Two-Way Radios

APX N50 Quick Start Guide

Model 2

en-US



SEPTEMBER 2024

© 2024 Motorola Solutions, Inc. All Rights Reserved.



PMLN8459C

Important Safety Information

RF Energy Exposure and Product Safety Guide for Portable Two-Way Radios

ATTENTION!



CAUTION:

This radio is restricted to Occupational use only. Before using the radio, read the RF Energy Exposure and Product Safety Guide for Portable Two-Way Radios which contains important operating instructions for safe usage and RF energy awareness and control for Compliance with applicable standards and Regulations.

Radio Overview

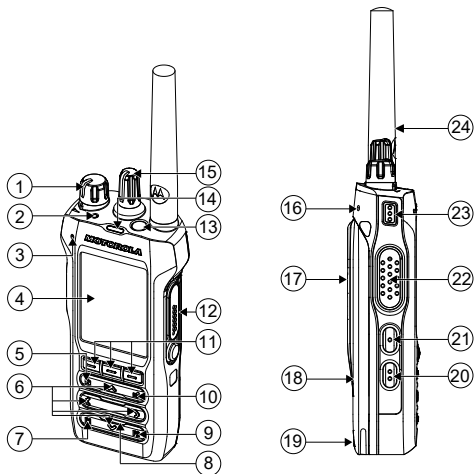

- | | |
|-------------------------------|------------------------------|
| 1. On/Off/Volume Control knob | 14 Top Light Bar |
| 2. Status LED | 15 Channel Selector knob |
| 3. Digital Mic 2 | 16 Digital Mic 1 |
| 4. Display | 17 Belt Clip Bracket |
| 5. Home button | 18 Battery |
| 6. 4-Way Navigation buttons | 19 Charging Contacts |
| 7. Programmable button 1 (P1) | 20 2-Dot Programmable button |
| 8. Speaker | 21 1-Dot Programmable button |
| 9. Programmable button 2 (P2) | 22 Push-to-Talk (PTT) button |
| 10. Notification button | 23 3-Dot Programmable button |
| 11. Menu Select buttons | 24 Antenna |
| 12. Accessory Connector | |
| 13. Top (Orange) button | |

Turning the Radio On or Off

Ensure that the battery is fully charged before the first use.

Turning the Radio On

Turn the **On/Off/Volume Control** knob clockwise until it clicks.

Turning the Radio Off

Turn the **On/Off/Volume Control** knob counterclockwise until it clicks.

Selecting Zones and Channels

Rotate the **Channel Selector** knob to the desired Channel.

Accessing Radio Call Activities

Perform one of the following actions:

- To call, press and hold the **PTT** button.
- To listen, release the **PTT** button.
- To adjust volume, turn the **On/Off/Volume Control** knob.
- To monitor, press the programmed **Monitor** button and listen.

Sending an Emergency Alarm

1. Press and hold the **Top (Orange)** button.
Your radio shows the following indications:
 - A tone sounds.
 - The red LED illuminates.
 - The display shows **Top (Orange)** and the current zone/channel.
 - When acknowledgment is received, you hear four beep tones; alarm ends; and radio exits emergency.
2. Press and hold the **Top (Orange)** button to exit emergency.

Sending an Emergency Call

1. Press the **Top (Orange)** button.
2. Press and hold the **PTT** button to speak.
3. Release the **PTT** button to end call.
4. Press and hold **Top (Orange)** button to exit emergency.

Sending a Silent Emergency Call

1. Press the **Top (Orange)** button.
2. Silent emergency continues until you perform one of the following:
 - Press and hold the **Top (Orange)** button to exit emergency state.
 - Press and release the **PTT** button to exit the Silent Emergency Alarm mode and enter regular dispatch or Emergency Call mode.

















Status Icons



Battery Level



Received Signal Strength Indicator (RSSI)

	RSSI Receiving		User Login Indicator (IP Packet Data)
	RSSI Transmitting		Data Activity
	Direct Mode		Bluetooth®
	Monitor		Wi-Fi Strength
	Power Level High		Blinking/Steady Dot
	Power Level Low		Vote Scan
	Scan		Bluetooth Connected
	Secure Operation		
	Advanced Encryption Standard (AES) Secure Operation		
	Global Positioning System (GPS)		



https://learning.motorolasolutions.com/User_Documentation

MOTOROLA, MOTO, MOTOROLA SOLUTIONS and the Stylized M logo are trademarks or registered trademarks of Motorola Trademark Holdings, LLC and are used under license. All other trademarks are the property of their respective owners. © 2024 Motorola Solutions, Inc. All Rights Reserved.